

PRODUCT SPECIFICATION

PROPERTY / TEST METHOD	SPECIFICATION
Volume Resistivity	1000 ohm-cm max
Stainless Steel (Skin Side) Adhesion (180° peel, grams per inch of width)	240 grams min ¹
Top Liner (Tie Side) Adhesion to Gel (grams per inch of width)	90 grams max
Bottom Liner (Skin Side) Adhesion to Gel (grams per inch of width)	90 grams max
Cytotoxicity	Pass
Primary Skin Irritation Test	Pass
Delayed Contact Hypersensitivity Test	Pass
Top Release Liner	2.5 mil, 0.064mm MDPE
Bottom Release Liner	5 mil, 0.127mm PET
Hydrogel Thickness	35 mils (+/- 5 mils)
Hydrogel pH	3.5 (+/- 0.5)
Roll Dimensions	Width - 8.75" usable gel, Length - 300'
Shelf Life	Slit - 6 months ² , Non-slit - 12 Months ²
Core Size	Slit - 3", Non-slit - 6"

¹ Stainless Steel is not a true measure of skin adhesion. AG602 has good "quick grab" and excellent restick.

² Shelf life is for roll goods prior to conversion. Shelf life for finished goods is the responsibility of the converter.

NOTE: Converter assumes responsibility for material compatibility. However, should assistance be required, our professional chemical and engineering staff is available to support your technical needs.

PACKAGING SPECIFICATION

MASTER ROLL DETAIL

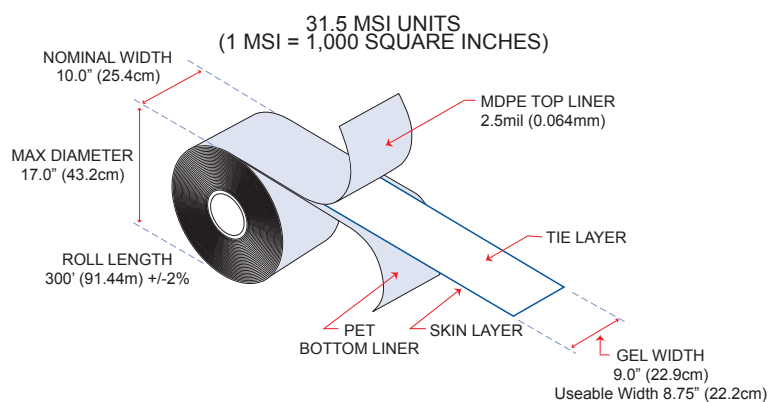

GEL ROLL PACKAGING

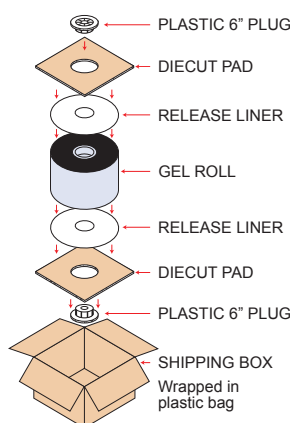

SLIT GEL ROLL PACKAGING

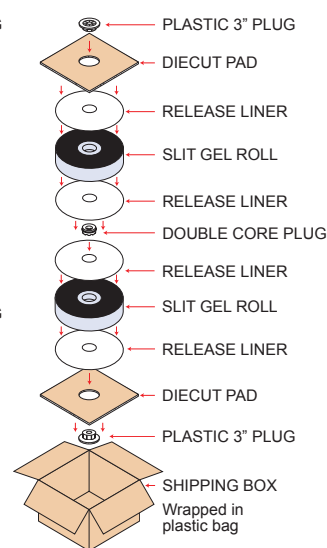

BOX SIZE AND WEIGHT: 17" x 17" x 12" APPROX. 68 lbs. (30.8 kg)

SHIPPING BY PALLET: 16 boxes (APPROX. 54"H x 45"W x 45"D) APPROX. 1,088 lbs. (493.5kg)

PROPER STORAGE CONDITIONS OF PACKAGED ROLLS

- Short Term (less than one month) Temperature: 32° - 104°F (0° - 40°C) Relative Humidity 35 - 50%
- Long Term and Optimal Temperature: 41° - 80.6°F (5° - 27°C) Relative Humidity 35 - 50%

TOLL FREE: +1 (877) 728-7315 • FAX: +1 (760) 728-3429 • INTERNATIONAL: +1 (760) 728-3480

E-MAIL: info@amgel.com • HEADQUARTERS: Fallbrook, CA 92028, USA • www.amgel.com